



TYPE

SYNCHRONE

EP

MONTAGE

ASSEMBLING

MONTAJE



1

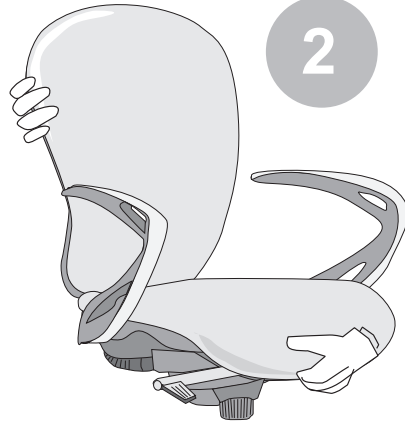
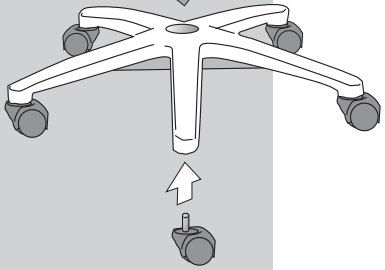

2

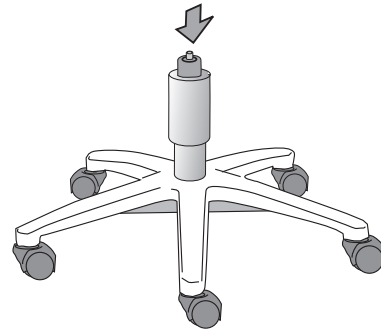

OK

3



TYPE

SYNCHRONE

EP

UTILISATION

USE

UTILIZACION

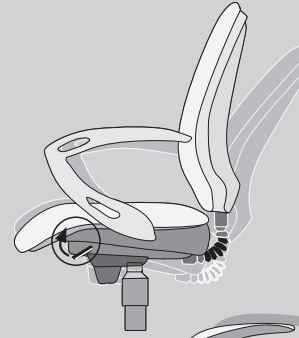

A

- SYNCHRO

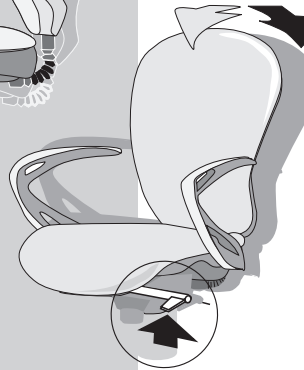

B

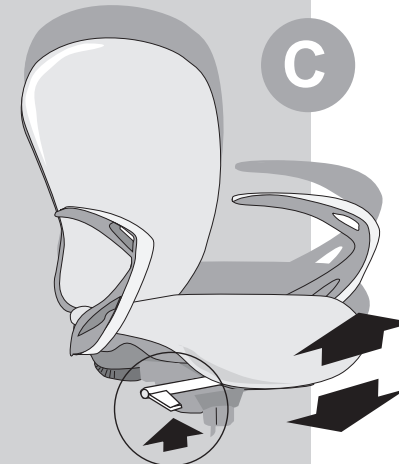
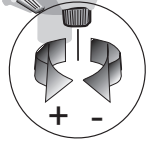

C

D

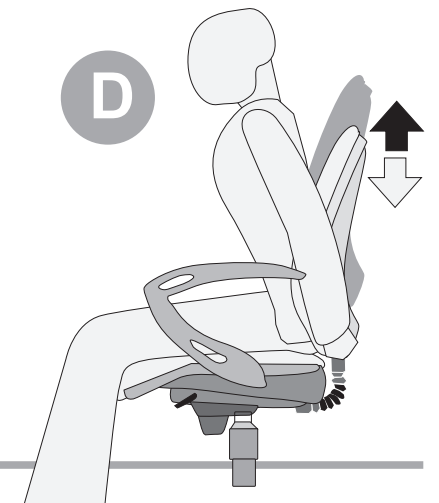



TYPE CONTACT PERMANENT



YNOTM.009

1.0

MONTAGE ASSEMBLY MONTAJE



TYPE CONTACT PERMANENT

UTILISATION USE UTILIZACION

